

**ATENCIÓN:** Schuller recomienda que utilice los balancines suministrados en la instalación de esta lámpara.

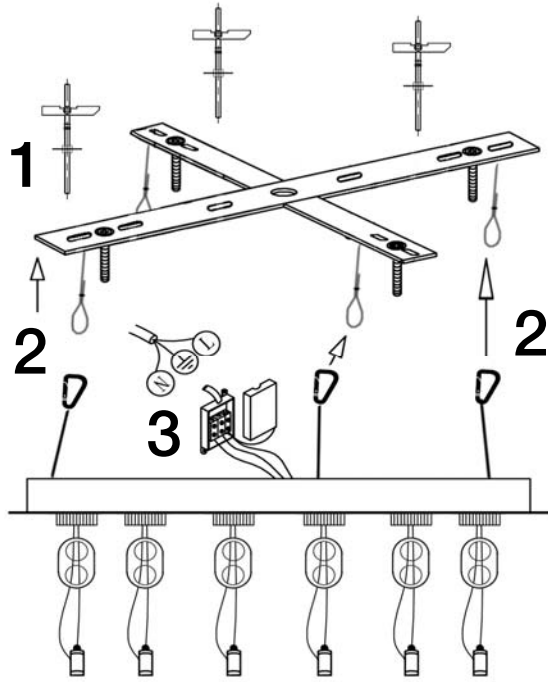

**ATENCIÓN**  
 Artículo pesado.  
 Realizar un anclaje seguro.



**NOTA IMPORTANTE**  
 El montaje y la manipulación de este artículo debe hacerse **entre dos personas**.

**ATENCIÓN**  
 Este producto incluye leds con dimado de 0-10V y **TRIAC**. Para utilizar con regulador de pared, usar sólo dimmers de estos dos tipos de regulación.

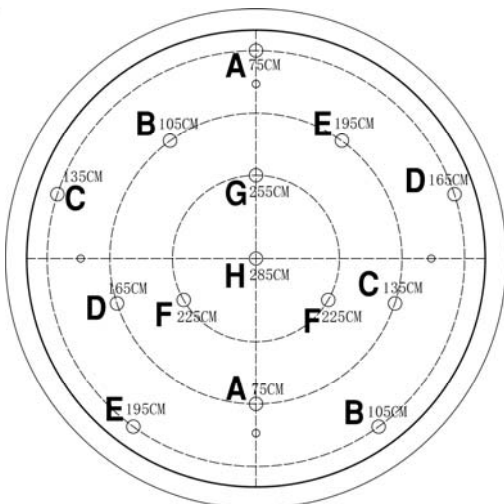
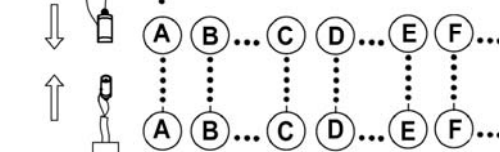
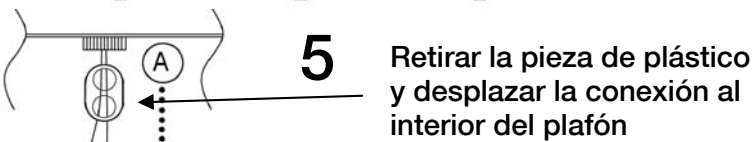
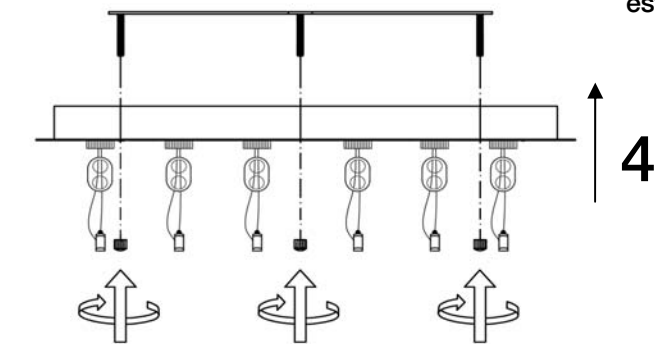
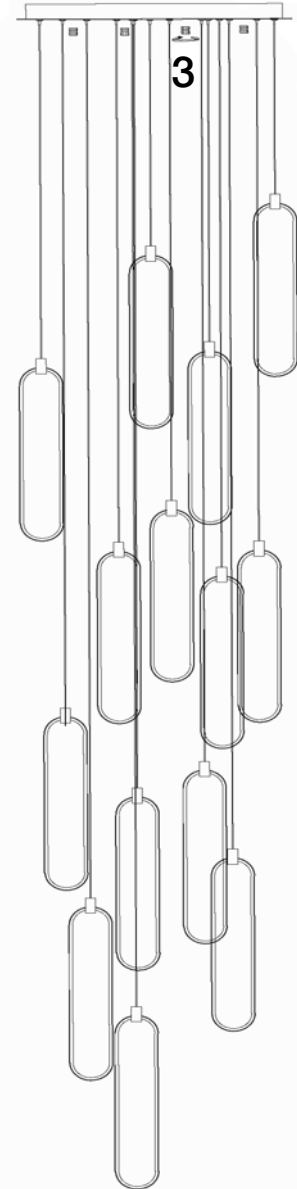

**Este producto incluye kit de dimado (Ref. 600811): interruptor inalámbrico y receptor dimable.**

Para ver la ficha técnica de producto completa, puede usar el siguiente código QR:



## Distintas opciones de instalación.

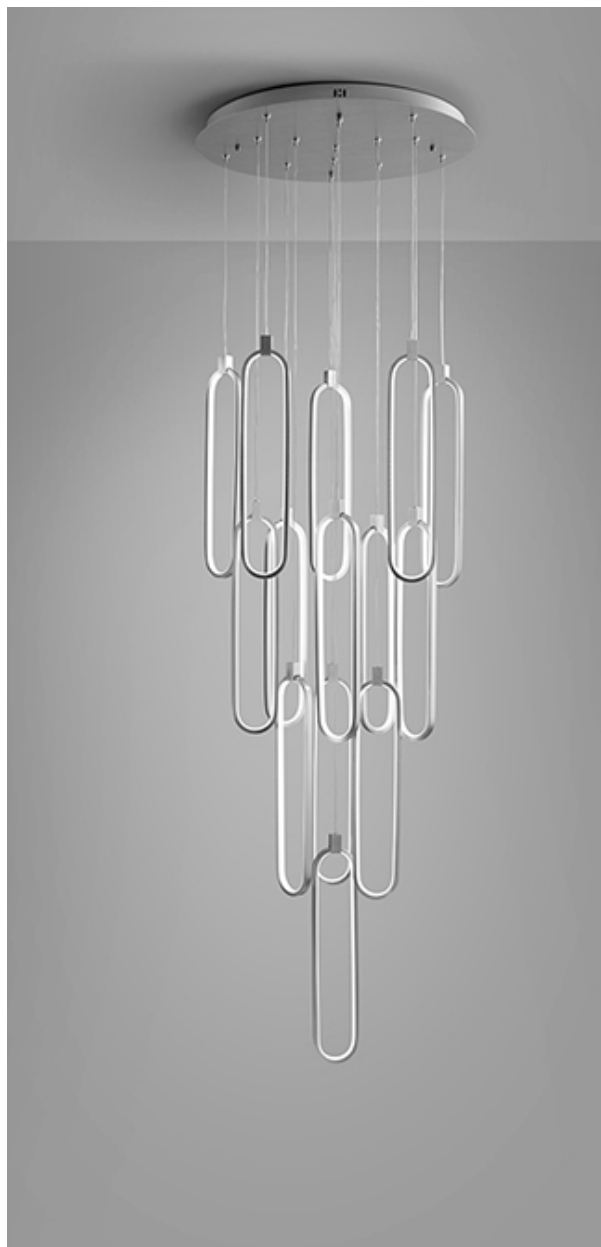
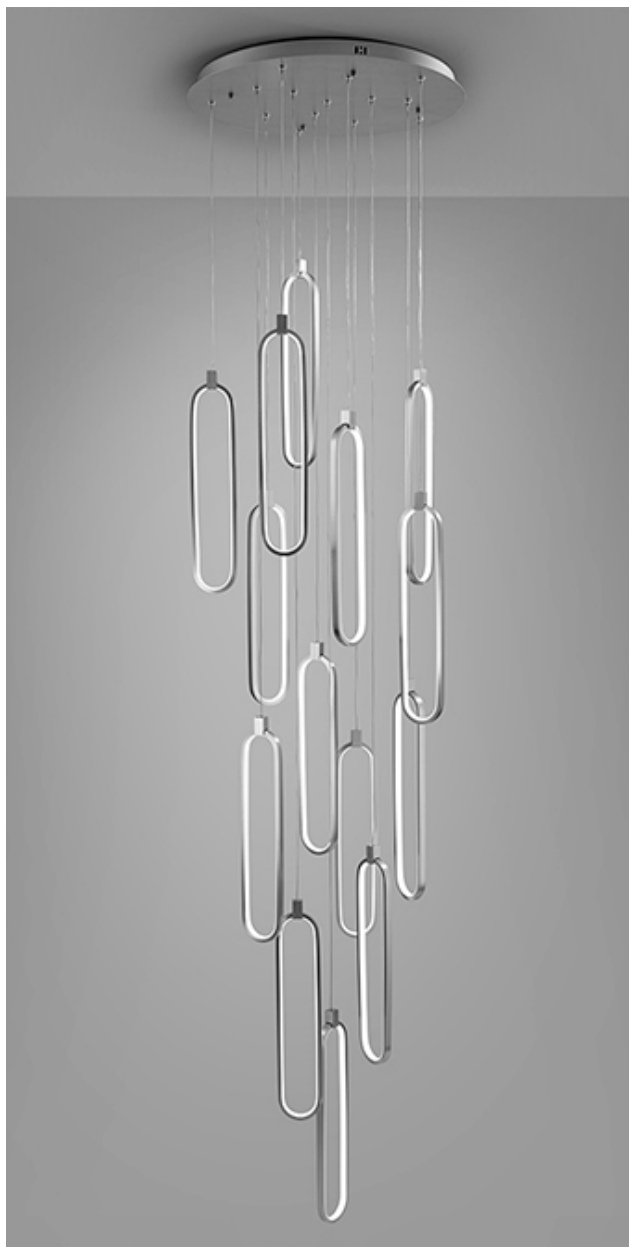

**ATTENTION:** Schuller recommends to use included special screws when installing this lamp.

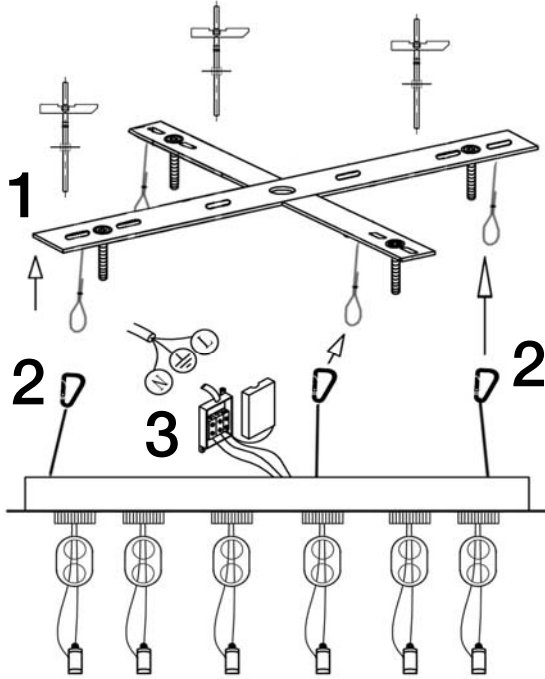

**WARNING**  
**Heavy item.**  
**Make sure it is properly fixed**



**IMPORTANT NOTE**  
 The assembly of this lamp must be done **by two people**

**ATTENTION**  
 This product includes LEDs with 0-10V and **TRIAC** dimming. To use it with wall dimmer, use just this type of dimmers.

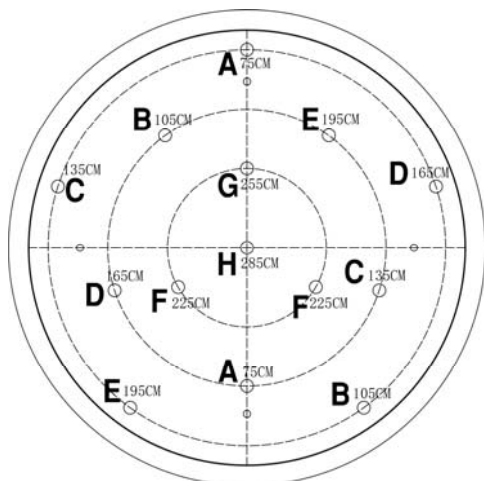
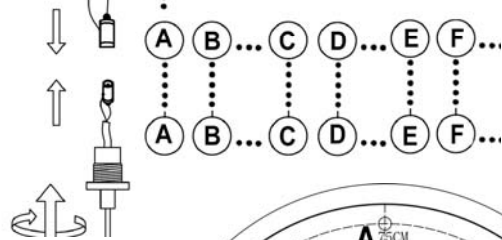
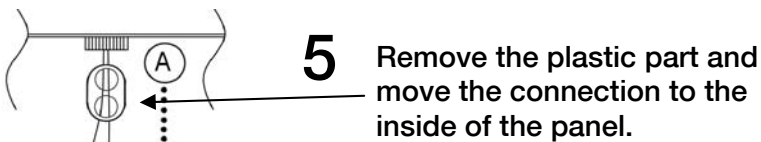
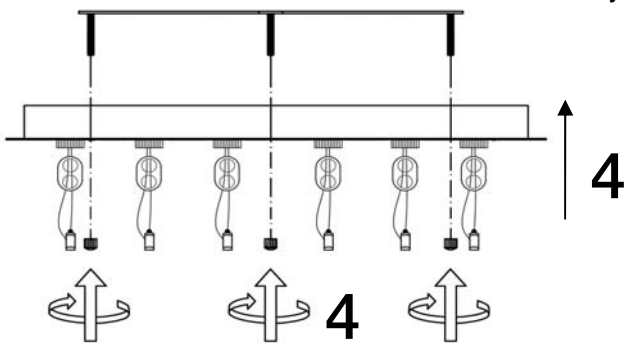
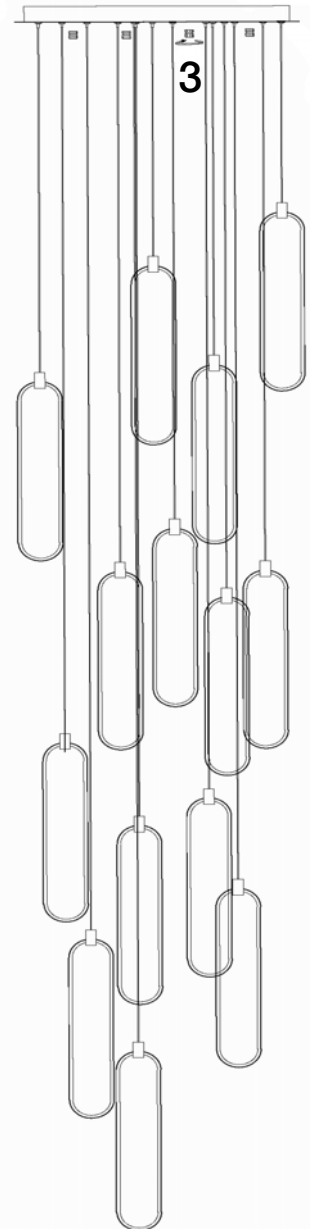

This product includes dimming kit (Ref. 600811): wireless switch and dimmable receiver.

You may use the following QR code to view the complete technical data sheet of the product:



Various installation options.

