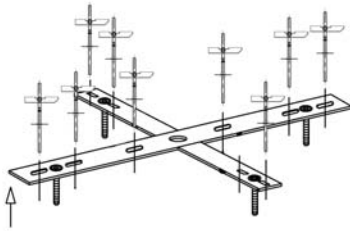
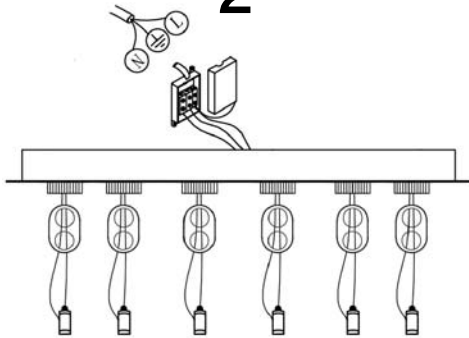
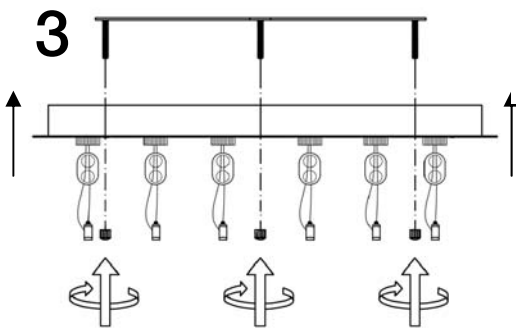
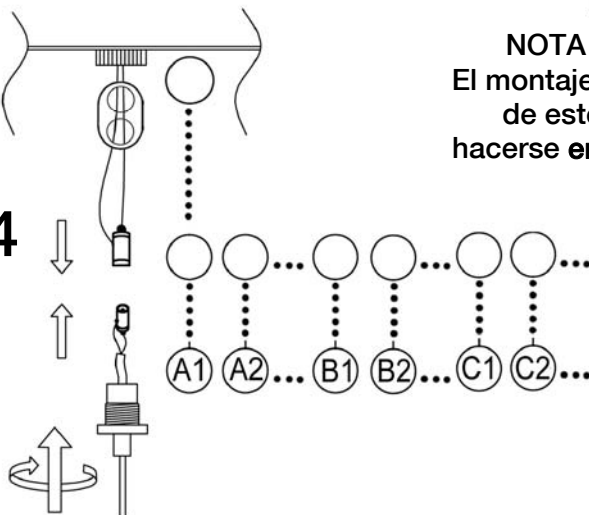
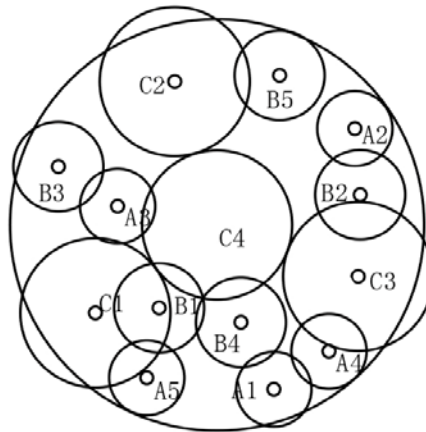

ATENCIÓN: Schuller recomienda que utilice los balancines suministrados en la instalación de esta lámpara.

1

2

3

4

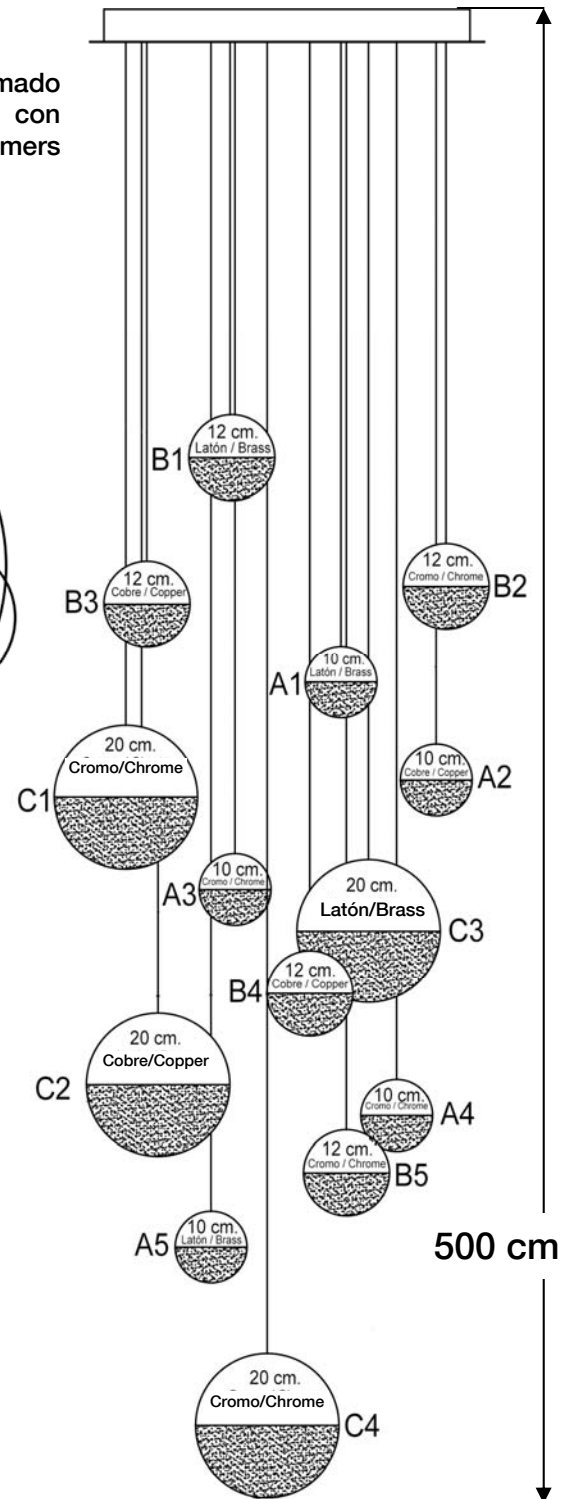
ATENCIÓN

Este producto incluye leds con dimado de 0-10V y **TRIAC**. Para utilizar con regulador de pared, usar sólo dimmers de estos dos tipos de regulación.



NOTA IMPORTANTE
 El montaje y la manipulación de este artículo debe hacerse **entre dos personas**.



Este producto incluye kit de dimado (Ref. 600811): interruptor inalámbrico y receptor dimable.

Para ver la ficha técnica de producto completa, puedes usar el siguiente código QR:



ATTENTION: Schuller recommends to use included special screws when installing this lamp.

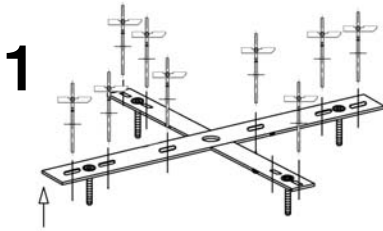

1

ATTENTION

This product includes LEDs with 0-10V and **TRIAC** dimming. To use it with wall dimmer, use just this type of dimmers.



2

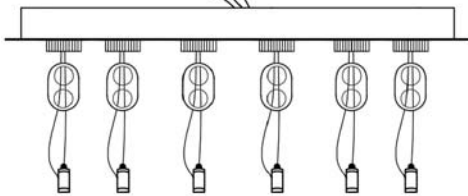

3

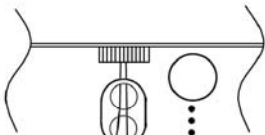
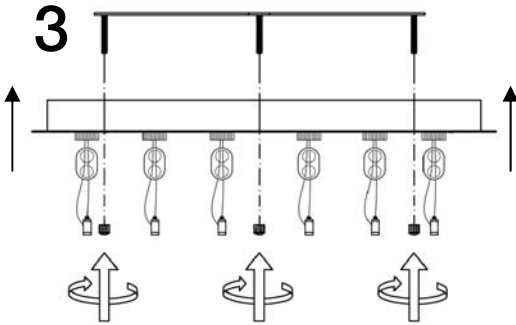
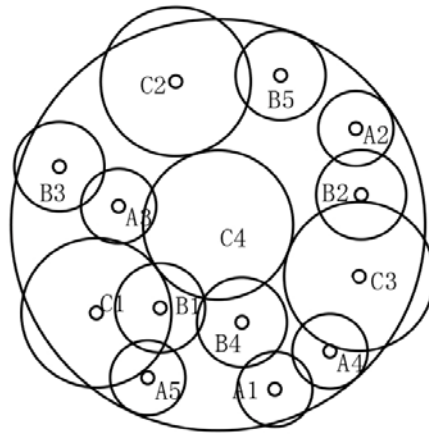

IMPORTANT NOTE
 The assembly of this lamp must be done by two people

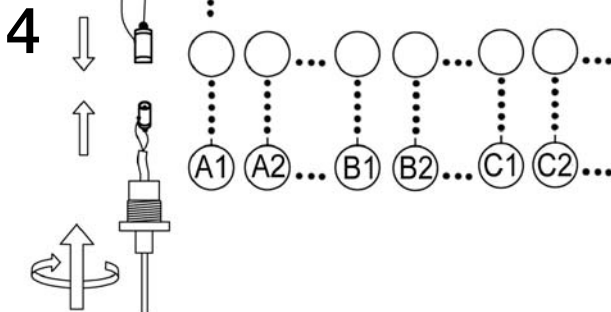

4

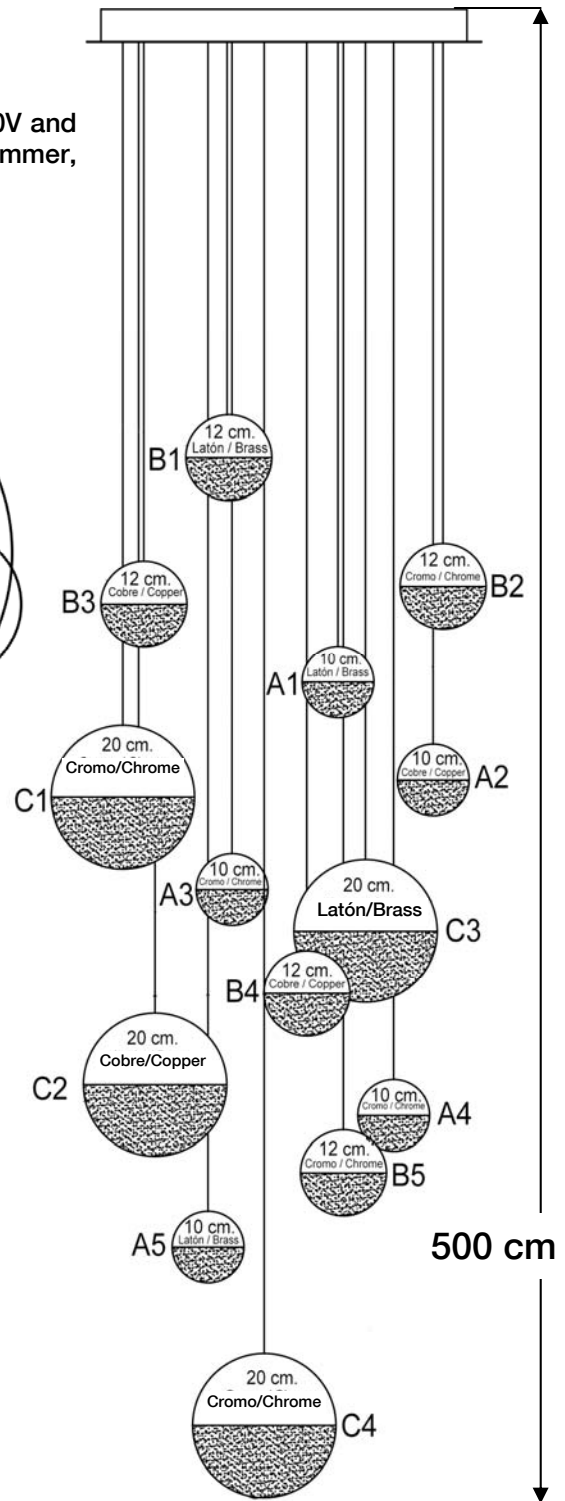

This product includes dimming kit (Ref. 600811): wireless switch and dimmable receiver.

You may use the following QR code to view the complete technical data sheet of the product:

